



MiniDumper C40

21/08/2018

This page is intentionally left blank.



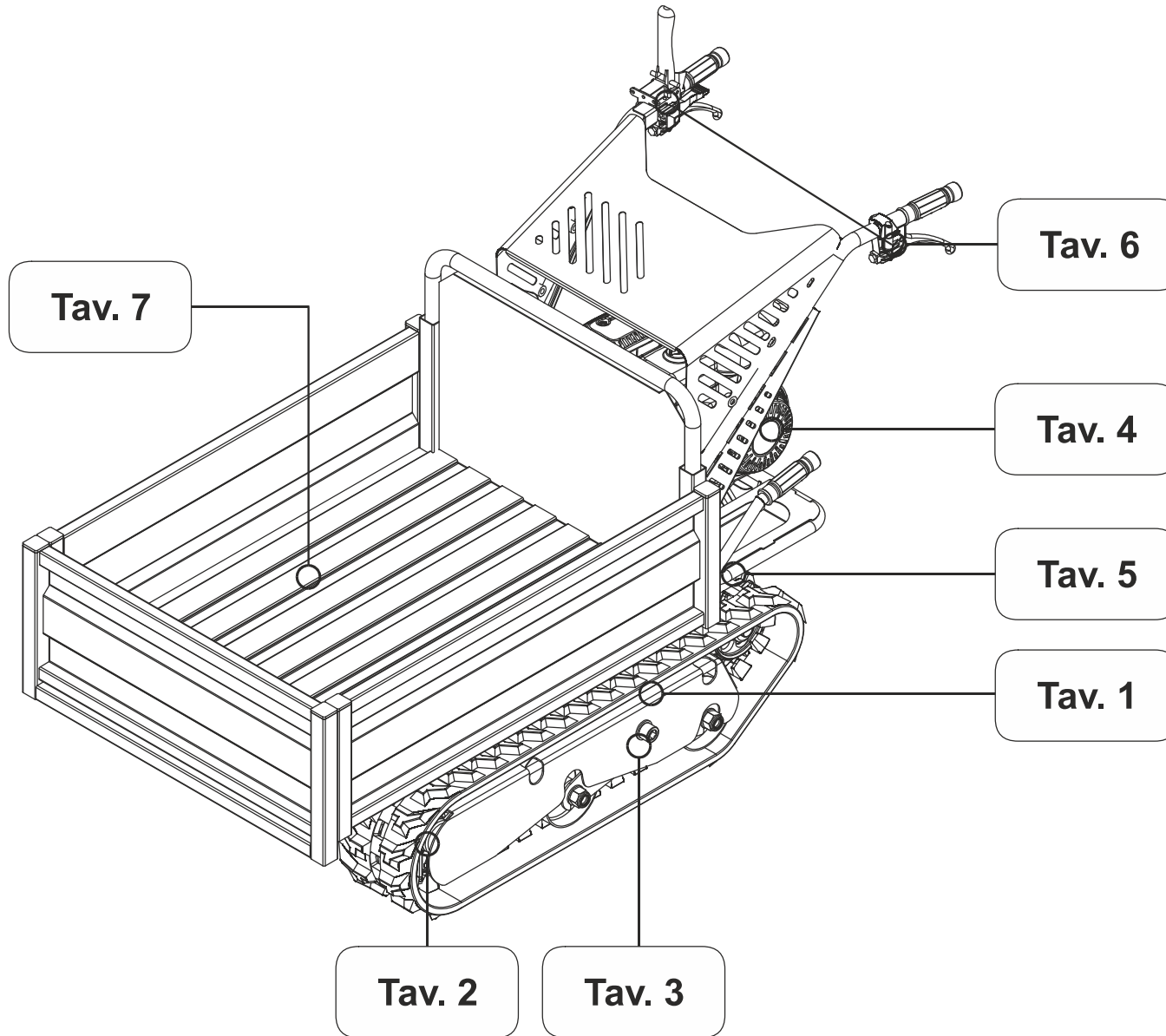





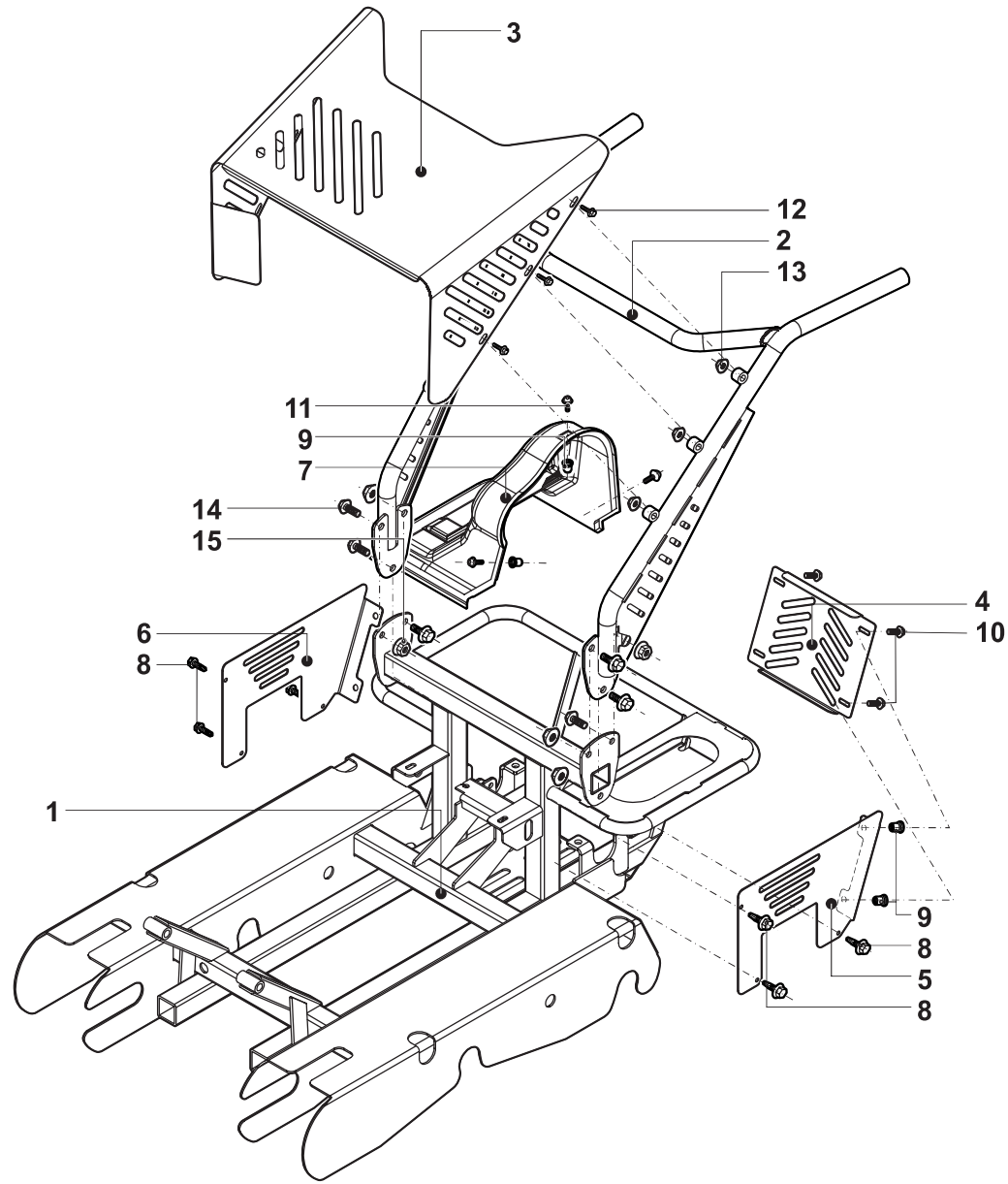





C40 - MiniDumper C40.....	4
CRD.35.901.0 - Frame.....	6
CRD.35.902.0 - Track Idler Group.....	8
CRD.35.903.0 - Transmission.....	10
CRD.35.904.0 - Motor.....	12
CRD.35.905.0 - Gearbox.....	16
CRD.35.905.1 - Gearbox.....	18
CRD.35.906.0 - Cables.....	20
CRD.35.907.0 - Skip.....	22
Components index.....	24











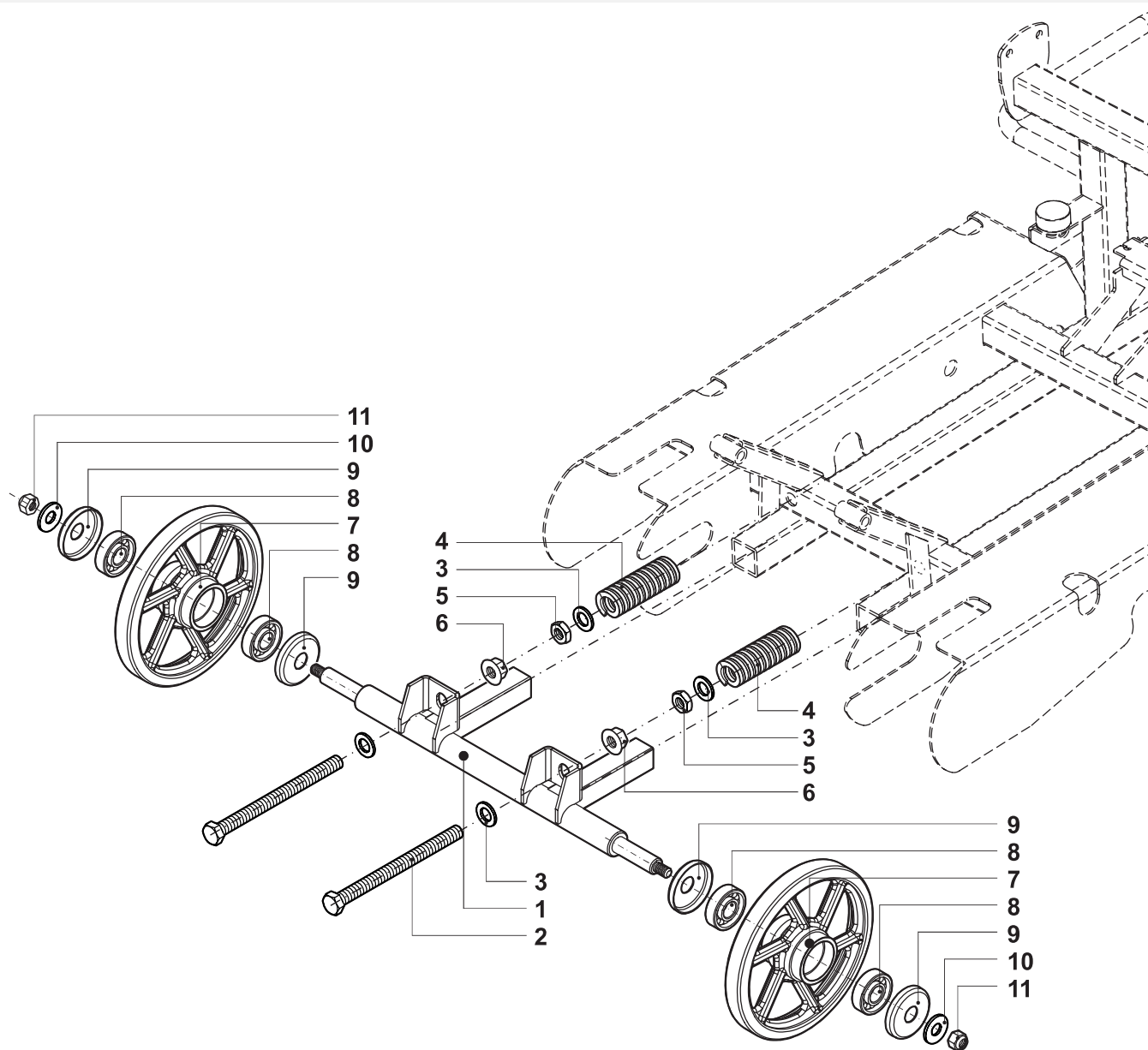



Pos.	Description
Tav. 1	Frame
Tav. 2	Track Idler Group
Tav. 3	Transmission
Tav. 4	Motor
Tav. 5	Gearbox
Tav. 5	Gearbox
Tav. 6	Cables
Tav. 7	Skip

Pos.	Description
Tav. 1	Frame
Tav. 2	Track Idler Group
Tav. 3	Transmission
Tav. 4	Motor
Tav. 5	Gearbox
Tav. 5	Gearbox
Tav. 6	Cables
Tav. 7	Skip









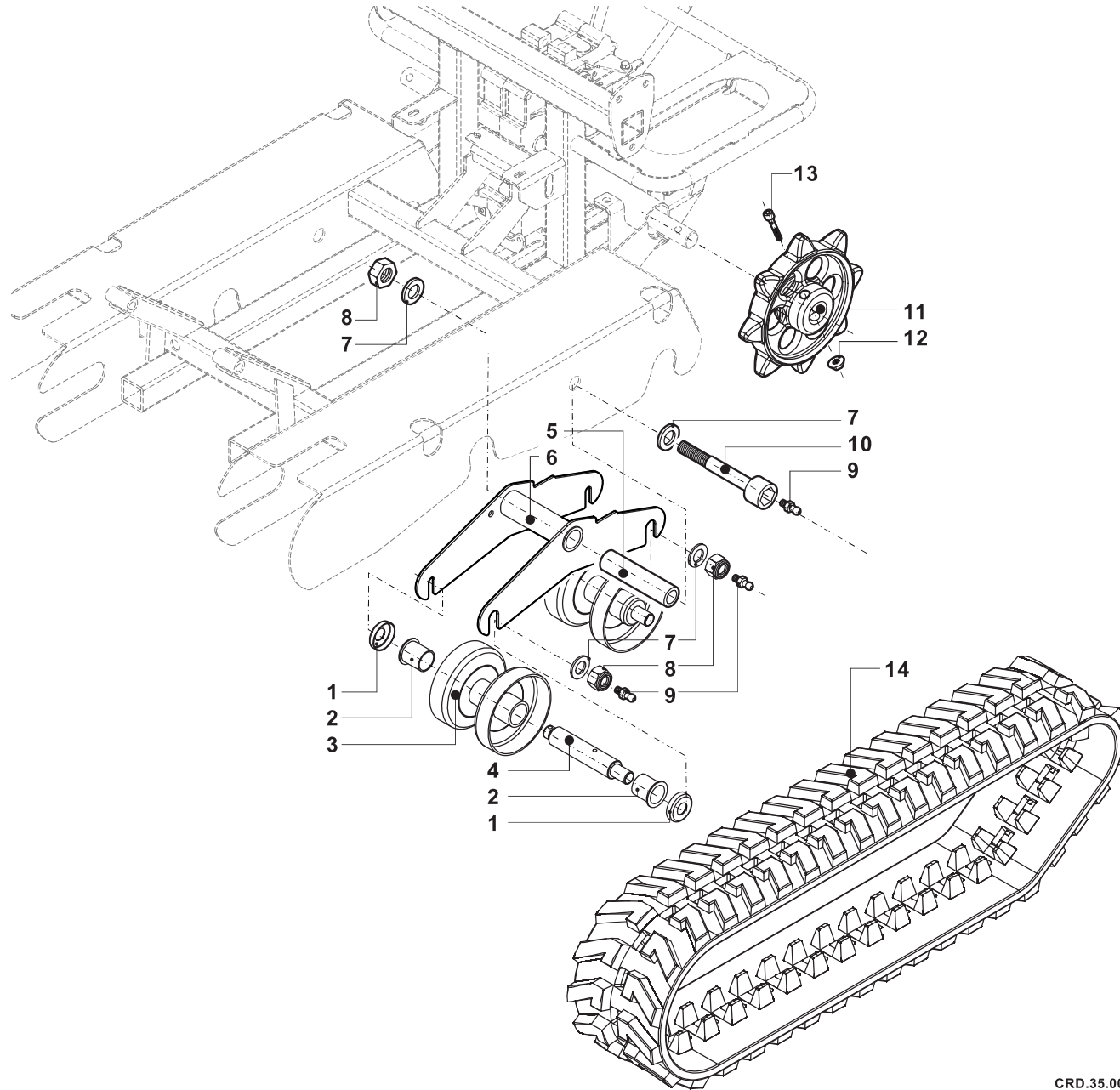





Purch.	Pos.	Code	Q.ty	Description	Specifications	Notes
	1	C2100.00.01	1	Frame		
	2	C2160.01.01	1	Manubrio		
	3	C2100.02.04	1	Upper Cover		
	4	C2100.02.01	1	Rear Cover		
	5	C2100.02.02	1	Cover L		
	6	C2100.02.03	1	Cover R		
	7	C2160.05.00	1	Hood		
	8	C2035	6	Hexagon Washer Head Self Drilling Screw	Ø6,3x22	
	9	C2063	7	Threaded Insert	Ø6	
	10	C2064	4	Flange Hex Head Cap Screw	M6x20	
	11	C0190.52.03	3	Hexagon Socket Button Head Cap Screw	M6x16	
	12	C2088	6	Flange Hex Head Cap Screw	M8x25	
	13	C2092	6	Flange nut	M8	
	14	C2050.03.00	6	Flange Hex Head Cap Screw	M10x20	
	15	C2019	6	Flange nut	M10	



Purch.	Pos.	Code	Q.ty	Description	Specifications	Notes
	1	C2140.22.01	1	Track Idler		
	2	C0190.26.15	2	Hex Head Cap Screw	M16x200	
	3	C2008	4	Flat washer	Ø16	
	4	C0097.00.01	2	Spring		
	5	C2033	2	Nut	M16	
	6	C0191.01.18	2	Flanged nut	M16	
	7	C2140.21.00	2	Tensioning Wheel		
	8	C1068	4	Ball Bearing		
	9	C1036.05.03	4	Mudguard Wash	Ø65	
	10	C2011	2	Flat washer	Ø12x36	
	11	C2023	2	Self-locking nut	M12	





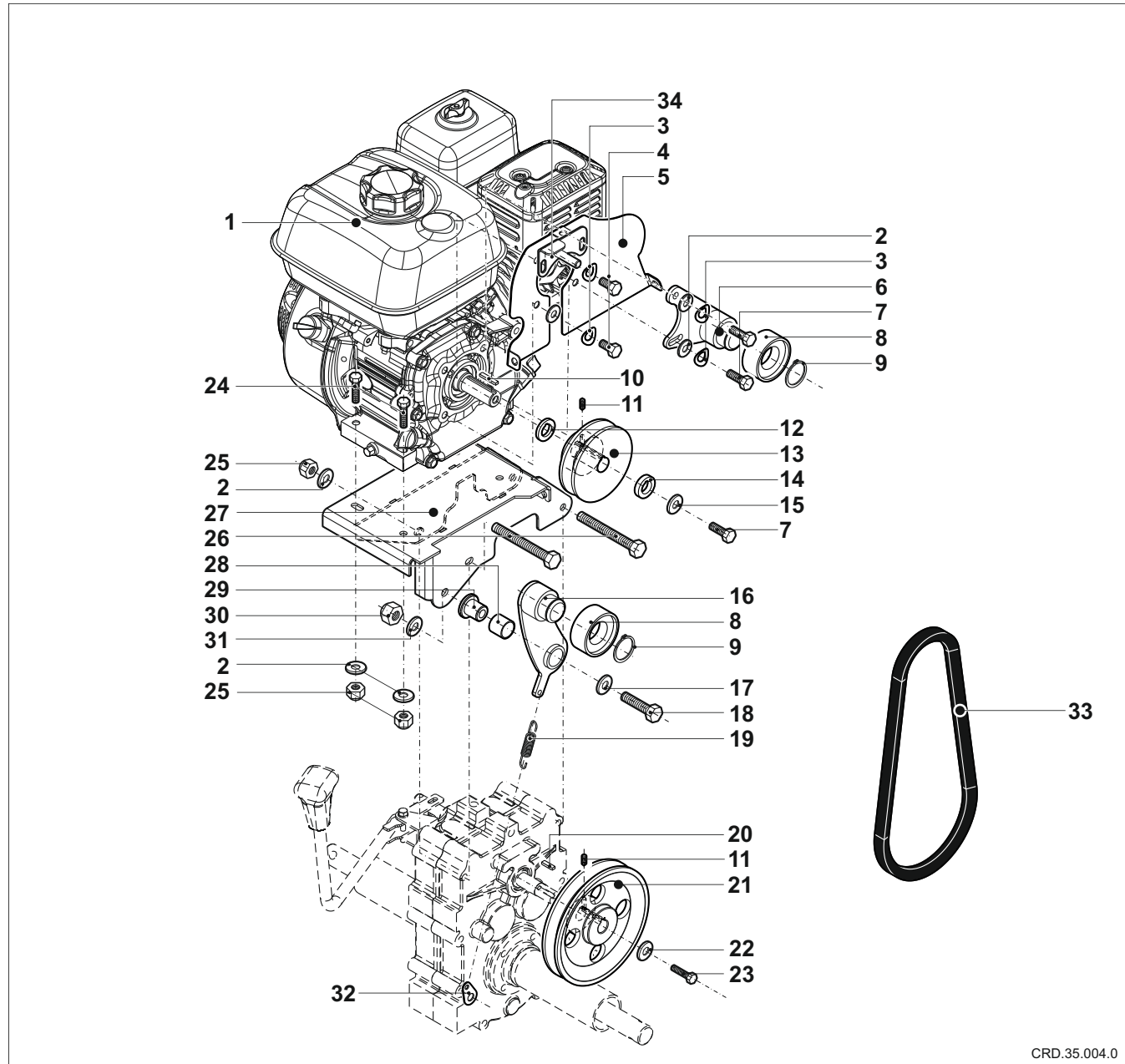

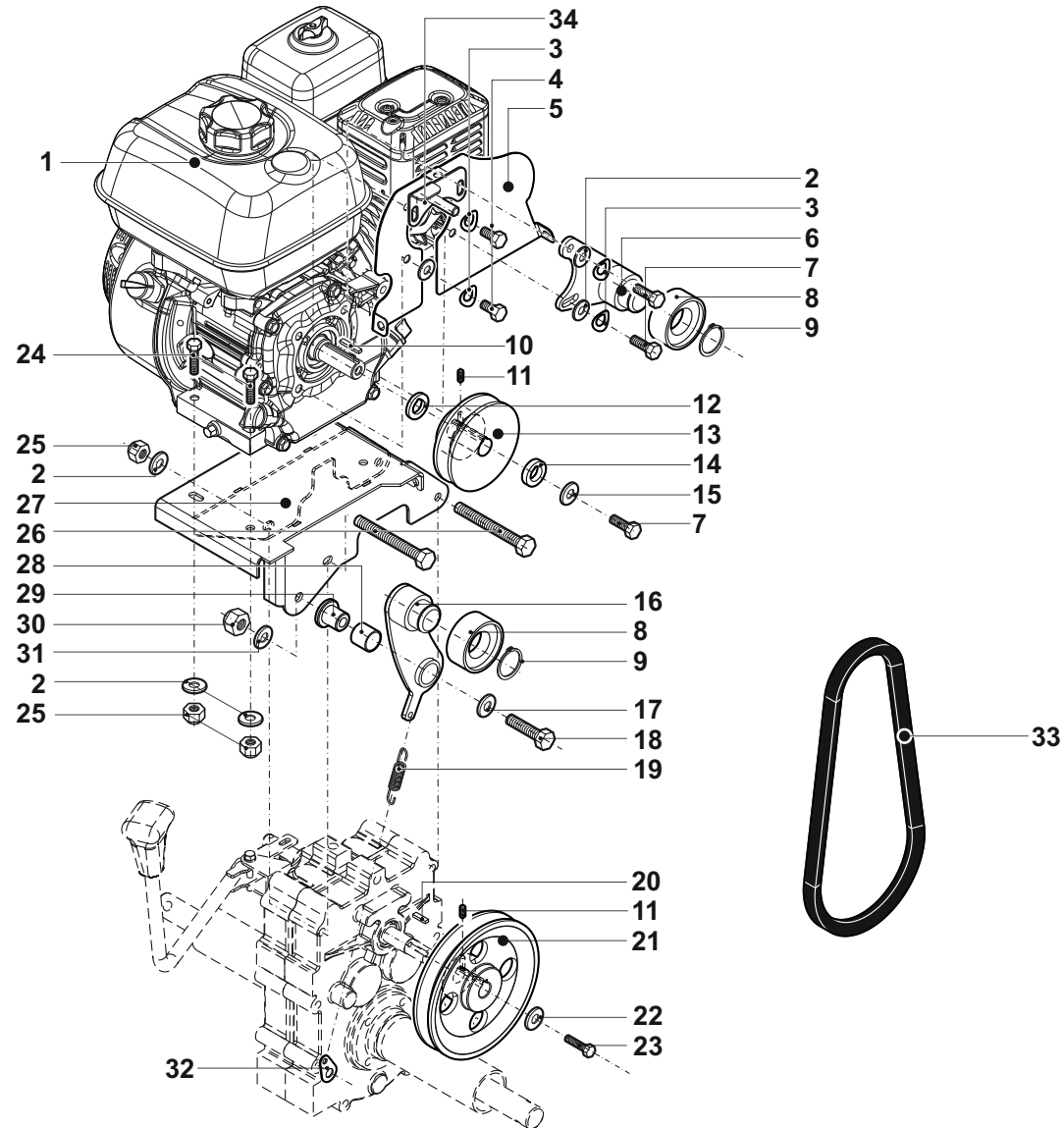

Purch.	Pos.	Code	Q.ty	Description	Specifications	Notes
	1	C1036.05.02	8	Mudguard Wash		
	2	C0093.02.53	8	Flanged bushing	MUF 30x26	
	3	C2140.06.00	4	Roller		Replacement time: 1h 00m
	4	C2140.07.00	4	Axle Shaft		
	5	C2140.07.01	2	Spacer		
	6	C2140.01.10	1	Oscillating L		
	6	C2140.01.11	1	Oscillating R		
	7	C2004	6	Flat washer	Ø20 ZN	
	8	C2025.00.01	8	Self-locking nut fine thread	M20	
	9	C0094.01.01	6	Grease nipple	M6	
	10	C2071.00.02	2	Pin w/greaser	M20x180	
	11	C2140.11.00	2	Drive Sprocket		
	14	C1062.00.04	2	Rubber Track	180x60x37	



Purch.	Pos.	Code	Q.ty	Description	Specifications	Notes
	1	C1258.02.00	1	Engine Honda GX 160	C40	
	1	C1258.12.00	1	Engine Briggs&Stratton S550	C35	
	2	C2001	6	Flat washer	Ø8	
	3	C0192.02.23	4	Curved Washer	M8	
	4	C0190.93.01	2	Vite T.E.	UNF 5/16x1/2	
	5	C2100.05.00	1	Plate Belt Guard		
	6	C2110.03.00	1	Belt Tensioner Fix		
	7	C0190.93.04	3	Vite T.E.	UNF 5/16x1	
	8	C0290.03.01	2	Tensioner Pulley		
	9	C0090.02.00	2	Seeger Ring	Ø30 ext.	
	10	C1023.00.10	1	Parallel Key	5x5x45	
	11	C2029.00.01	2	Set Screw	M6x6 Cone Point	
	12	C2110.02.03	1	Spacer	H=5	H=5
	13	C2110.02.00	1	Pulley Motor		
	14	C2110.02.02	1	Spacer	H=8	H=8
	15	C2007.01.00	1	Flat washer	Ø8x32x2,5	
	16	C2110.03.02	1	Belt Tensioner		
	17	C0192.01.11	1	Plain Washer	M10x30	
	18	C2051	1	Hex Head Cap Screw	M10x45	
	19	C0097.02.01	1	Traction Spring		
	20	C1023.00.11	1	Parallel Key	5x5x26	
	21	C2110.02.01	1	Pulley Gearbox		
	22	C2000.01.01	1	Flat washer	Ø6x24	
	23	C0190.22.02	1	Hex Head Cap Screw	M6x16	
	24	C0190.23.06	4	Hex Head Cap Screw	M8x40	
	25	C2021	6	Self-locking nut	M8	
	26	C0190.23.13	2	Hex Head Cap Screw	M8x100	
	27	C2100.03.00	1	Motor Support		
	28	C0093.02.05	1	Bushing	MU 20x20	



Purch.	Pos.	Code	Q.ty	Description	Specifications	Notes
	29	C2110.03.04	1	Bushing		
	30	C2022	1	Self-locking nut	M10	
	31	C2000	4	Flat washer	Ø6	
	32	C2110.03.05	1	Spring Attach		
	33	C1127.14.07	1	Belt		
	34	C2110.03.06	1	Block Belt		

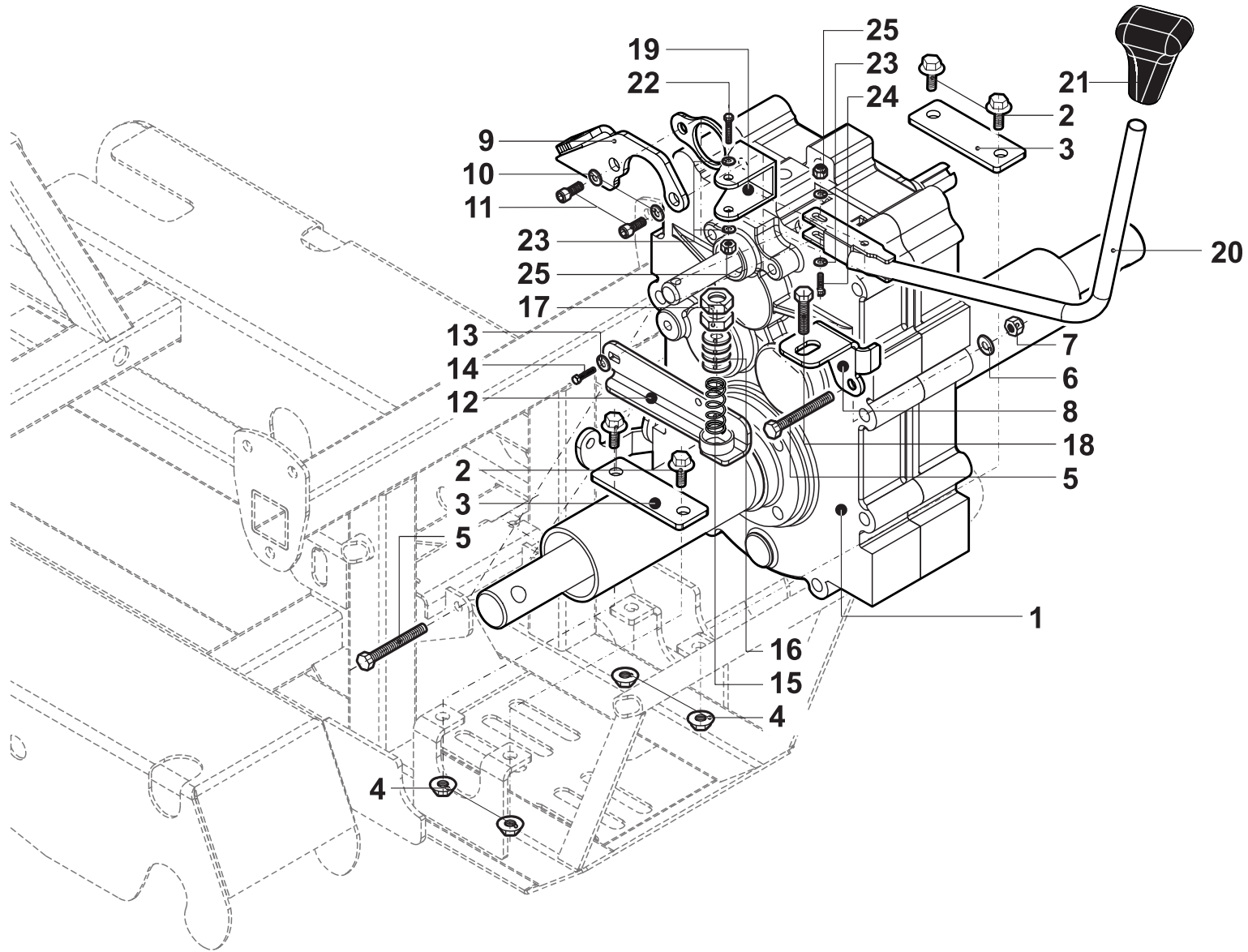



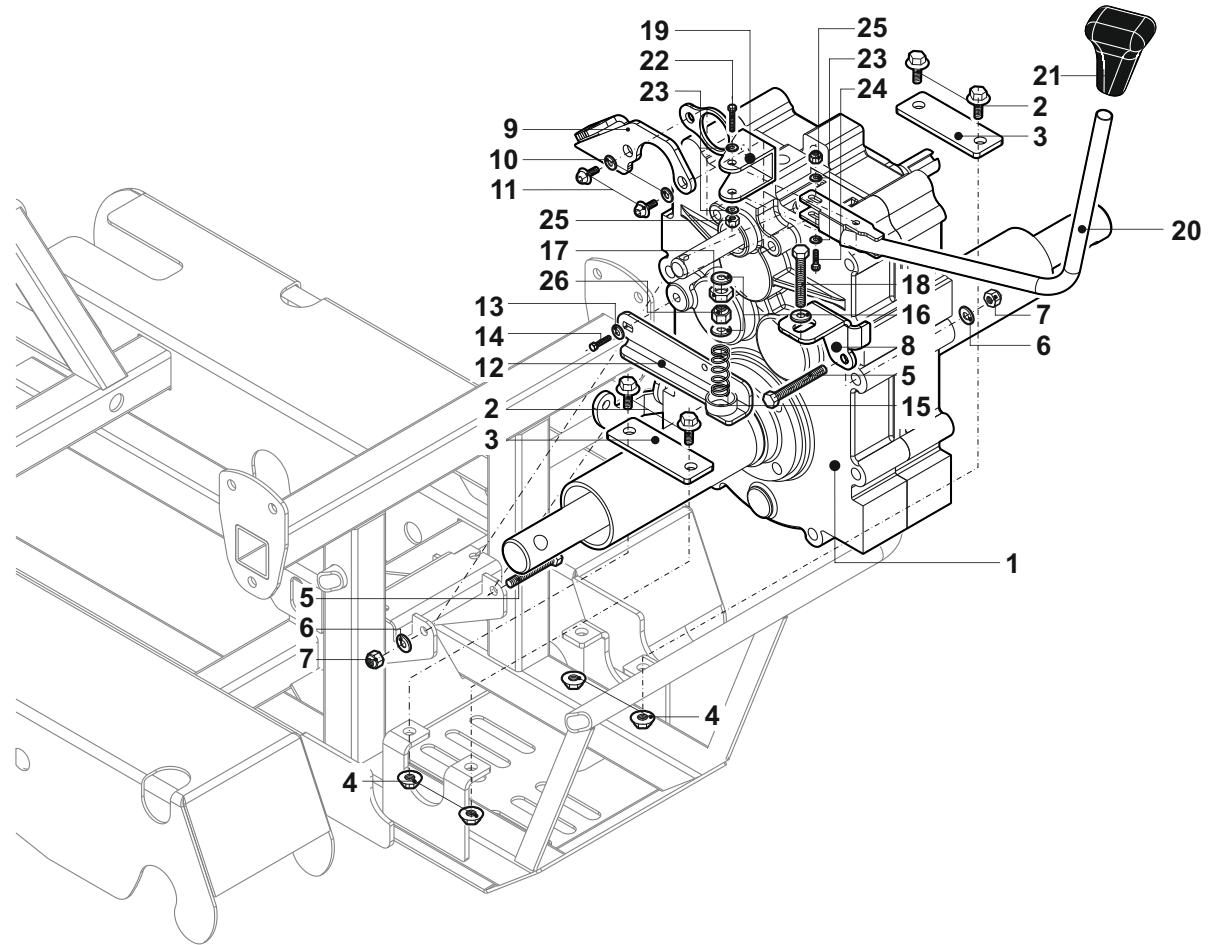



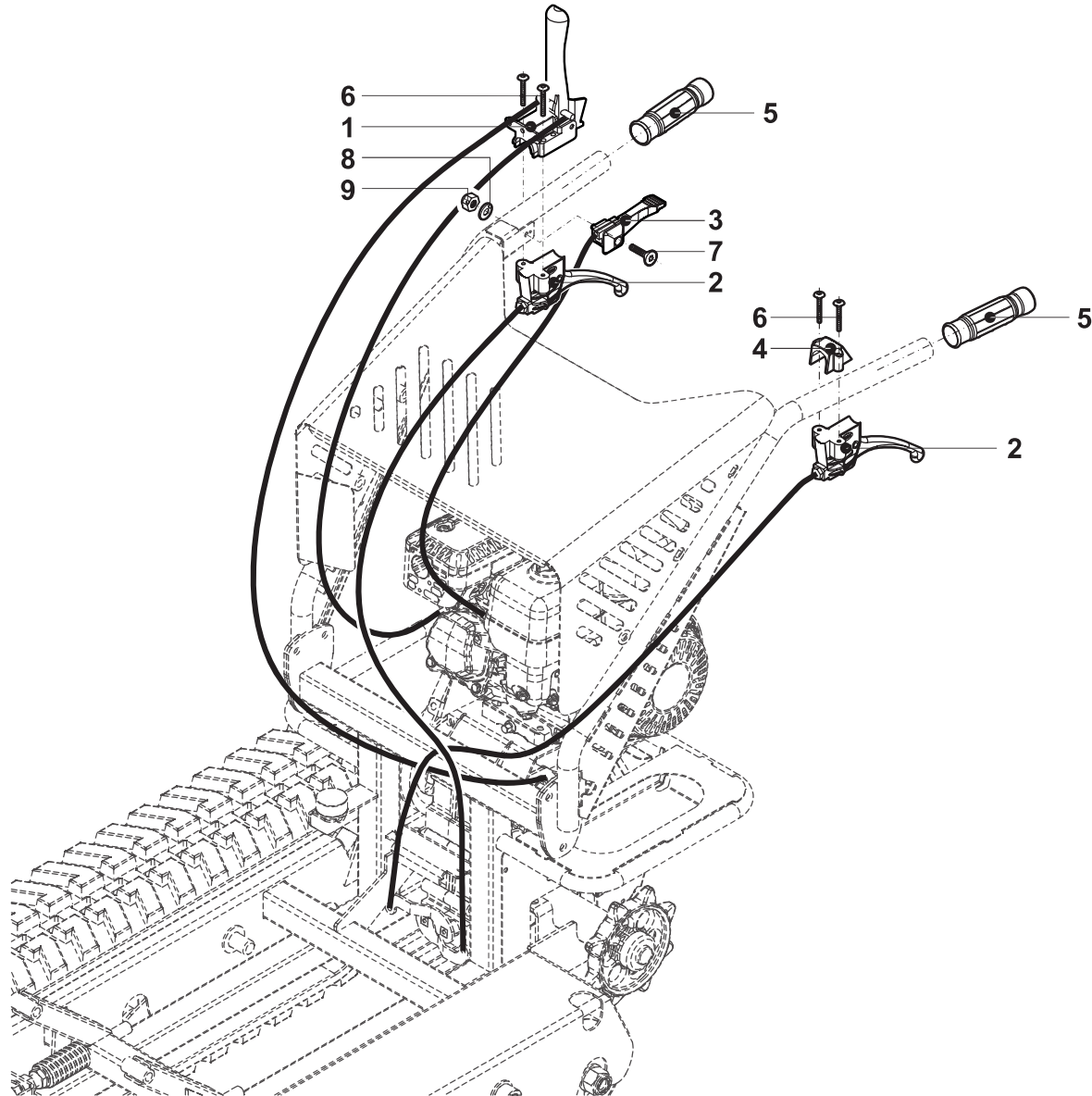

Purch.	Pos.	Code	Q.ty	Description	Specifications	Notes
🛒	1	C2110.01.01	1	Gearbox		
	1	C2110.01.01.t	1	Gearbox Replacing Time		
🛒	2	C2050.03.00	4	Flange Hex Head Cap Screw	M10x20	
🛒	3	C2100.04.00	2	Mounting plate		
🛒	4	C2019	4	Flange nut	M10	
🛒	5	C0190.23.13	2	Hex Head Cap Screw	M8x100	
🛒	6	C2001	2	Flat washer	Ø8	
🛒	7	C2021	2	Self-locking nut	M8	
🛒	8	C2160.04.02	1	Bracket		
🛒	9	C2160.04.00	1	Brake Bracket		
🛒	10	C0192.02.23	2	Curved Washer	M8	
🛒	11	C0190.03.03	2	Hexagon Socket Head Cap Screw	M8x16	
🛒	12	C2160.04.01	1	Brake Lever		
🛒	13	C2000.02.00	1	Flat washer	Ø5	
🛒	14	C0190.21.02	1	Hex Head Cap Screw	M5x16	
🛒	15	C3040.13.06	1	Spring		
🛒	16	C2003	6	Flat washer	Ø12	
🛒	17	C2023.01.00	2	Nut	M12	
🛒	18	C0190.25.07	1	Hex Head Cap Screw	M12x50	
🛒	19	C2110.01.02	1	Flange		
🛒	20	C2110.01.03	1	Gearshift lever		
🛒	21	C1053.10.02	1	Knob	Ø10	
🛒	22	C2041	1	Hex Head Cap Screw	M6x40	
🛒	23	C2000	4	Flat washer	Ø6	
🛒	24	C0190.22.05	1	Hex Head Cap Screw	M6x30	
🛒	25	C2020	2	Self-locking nut	M6	









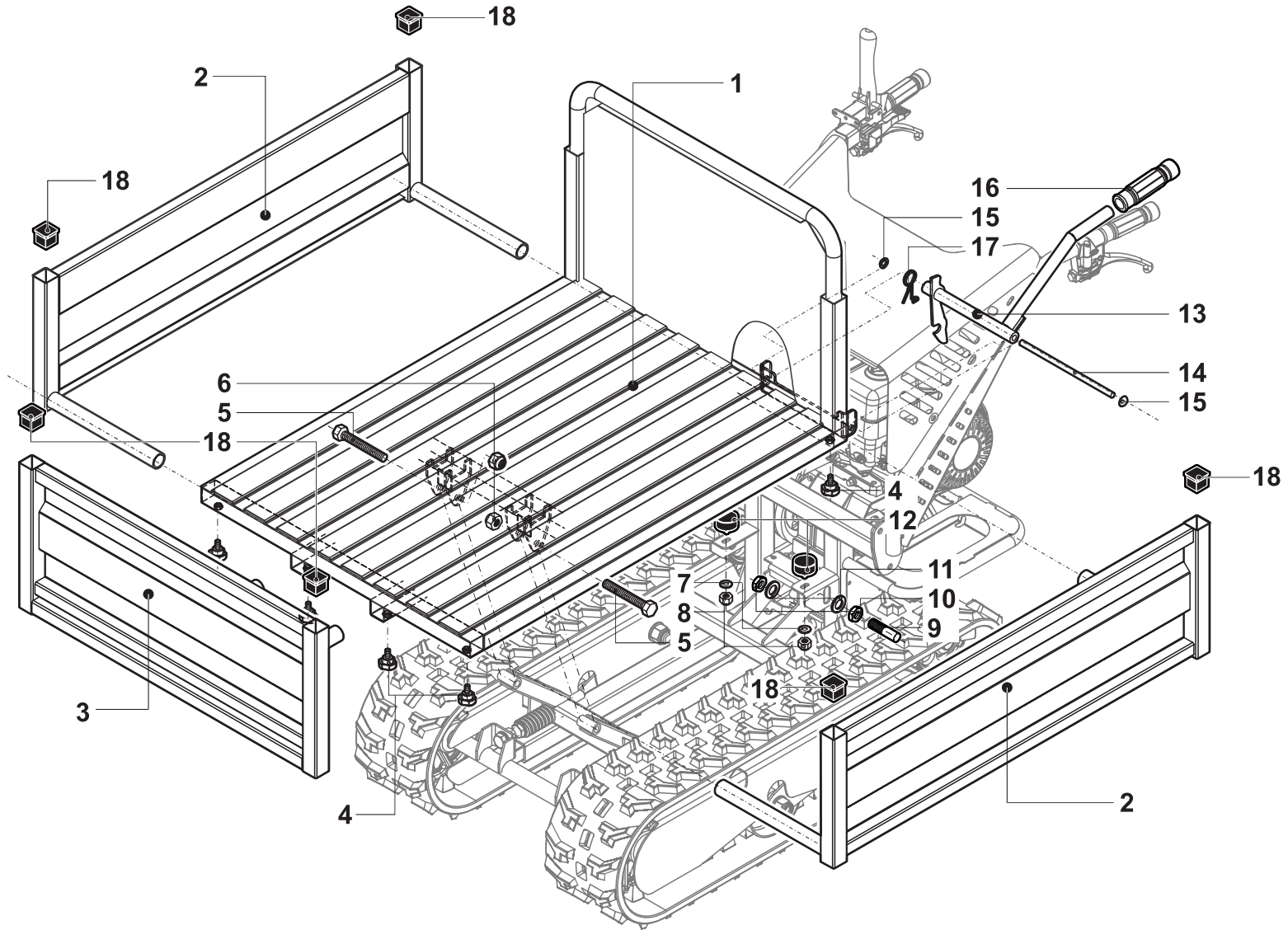











Purch.	Pos.	Code	Q.ty	Description	Specifications	Notes
	1	C2110.01.01	1	Gearbox		
	2	C2050.03.00	4	Flange Hex Head Cap Screw	M10x20	
	3	C2100.04.00	2	Mounting plate		
	4	C2019	4	Flange nut	M10	
	5	C0190.23.13	2	Hex Head Cap Screw	M8x100	
	6	C2001	2	Flat washer	Ø8	
	7	C2021	2	Self-locking nut	M8	
	8	C2160.04.02	1	Bracket		
	9	C2160.04.00	1	Brake Bracket		
	10	C0192.02.23	2	Curved Washer	M8	
	11	C0190.53.01	2	Hexagon Socket Button Head Cap Screw	M8x16	
	12	C2160.04.01	1	Brake Lever		
	13	C2000.02.00	1	Flat washer	Ø5	
	14	C0190.21.02	1	Hex Head Cap Screw	M5x16	
	15	C3040.13.06	1	Spring		
	16	C2003	2	Flat washer	Ø12	
	17	C2023.01.00	1	Nut	M12	
	18	C2062	1	Hex Head Cap Screw	M12x70	
	19	C2110.01.02	1	Flange		
	20	C2110.01.03	1	Gearshift lever		
	21	C1053.10.02	1	Knob	Ø10	
	22	C2041	1	Hex Head Cap Screw	M6x40	
	23	C2000	4	Flat washer	Ø6	
	24	C0190.22.05	1	Hex Head Cap Screw	M6x30	
	25	C2020	2	Self-locking nut	M6	
	26	C2023	1	Self-locking nut	M12	



Purch.	Pos.	Code	Q.ty	Description	Specifications	Notes
	1	C2110.08.00	1	Clutch Lever Assembly		
	2	C2110.07.00	2	Brake Lever Assembly		
	3	C2110.06.00	1	Lever Throttle Control		
	4	C2110.05.00	1	Lever Collar	D.27	
	5	C1014.00.02	2	Rubber handle	D.27	
	6	C0190.45.10	4	Torx Pan Head Self Tapping Screw Type F	M5x40	
	7	C0190.62.07	1	Countersunk Flat Head Screw Split	M6X45	
	8	C2000	1	Flat washer	Ø6	
	9	C2020	1	Self-locking nut	M6	



Purch.	Pos.	Code	Q.ty	Description	Specifications	Notes
	1	C2130.01.03	1	Flatbed		
	2	C2130.01.02	2	Drop Side		
	3	C2130.01.01	1	Drop Side		
	4	C1052.01.01	6	Knob	M8x15	
	5	C2062	2	Hex Head Cap Screw	M12x70	
	6	C2023	2	Self-locking nut	M12	
	7	C2001.00.04	2	Flat washer	Ø8,4	
	8	C2021	2	Self-locking nut	M8	
	9	C2130.03.00	1	Lock Pin		
	10	C2033	2	Nut	M16	
	11	C2008	2	Flat washer	Ø16	
	12	C1184	2	Anti-vibration mount	Ø40 h20 M8	Replacement time: 0h 05m
	13	C2130.02.00	1	Release Lever		
	14	C2130.02.01	1	Pin		
	15	C0300.00.01	2	Starlock washer capped	D10	
	16	C1014.00.01	1	Rubber handle	D.20	
	17	C0097.01.01	1	Torsion Spring		
	18	C1010.00.01	6	Plug		

Code	Parts Table	Pos.	Q.ty
C0090.02.00	CRD.35.904.0	9	2
C0093.02.05	CRD.35.904.0	28	1
C0093.02.53	CRD.35.903.0	2	8
C0094.01.01	CRD.35.903.0	9	6
C0097.00.01	CRD.35.902.0	4	2
C0097.01.01	CRD.35.907.0	17	1
C0097.02.01	CRD.35.904.0	19	1
C0190.03.03	CRD.35.905.0	11	2
C0190.21.02	CRD.35.905.0	14	1
	CRD.35.905.1	14	1
C0190.22.02	CRD.35.904.0	23	1
C0190.22.05	CRD.35.905.0	24	1
	CRD.35.905.1	24	1
C0190.23.06	CRD.35.904.0	24	4
C0190.23.13	CRD.35.904.0	26	2
	CRD.35.905.0	5	2
	CRD.35.905.1	5	2
C0190.25.07	CRD.35.905.0	18	1
C0190.26.15	CRD.35.902.0	2	2
C0190.45.10	CRD.35.906.0	6	4
C0190.52.03	CRD.35.901.0	11	3
C0190.53.01	CRD.35.905.1	11	2
C0190.62.07	CRD.35.906.0	7	1
C0190.93.01	CRD.35.904.0	4	2
C0190.93.04	CRD.35.904.0	7	3
C0191.01.18	CRD.35.902.0	6	2
C0192.01.11	CRD.35.904.0	17	1
C0192.02.23	CRD.35.904.0	3	4
	CRD.35.905.0	10	2
	CRD.35.905.1	10	2
C0290.03.01	CRD.35.904.0	8	2

Code	Parts Table	Pos.	Q.ty
C0300.00.01	CRD.35.907.0	15	2
C1010.00.01	CRD.35.907.0	18	6
C1014.00.01	CRD.35.907.0	16	1
C1014.00.02	CRD.35.906.0	5	2
C1023.00.10	CRD.35.904.0	10	1
C1023.00.11	CRD.35.904.0	20	1
C1036.05.02	CRD.35.903.0	1	8
C1036.05.03	CRD.35.902.0	9	4
C1052.01.01	CRD.35.907.0	4	6
C1053.10.02	CRD.35.905.0	21	1
	CRD.35.905.1	21	1
C1062.00.04	CRD.35.903.0	14	2
C1068	CRD.35.902.0	8	4
C1127.14.07	CRD.35.904.0	33	1
C1184	CRD.35.907.0	12	2
C1258.02.00	CRD.35.904.0	1	1
C1258.12.00	CRD.35.904.0	1	1
C2000	CRD.35.904.0	31	4
	CRD.35.905.0	23	4
	CRD.35.905.1	23	4
	CRD.35.906.0	8	1
C2000.01.01	CRD.35.904.0	22	1
C2000.02.00	CRD.35.905.0	13	1
	CRD.35.905.1	13	1
C2001	CRD.35.904.0	2	6
	CRD.35.905.0	6	2
	CRD.35.905.1	6	2
C2001.00.04	CRD.35.907.0	7	2
C2003	CRD.35.905.0	16	6
	CRD.35.905.1	16	2
C2004	CRD.35.903.0	7	6

Code	Parts Table	Pos.	Q.ty
C2007.01.00	CRD.35.904.0	15	1
C2008	CRD.35.902.0	3	4
	CRD.35.907.0	11	2
C2011	CRD.35.902.0	10	2
C2019	CRD.35.901.0	15	6
	CRD.35.905.0	4	4
	CRD.35.905.1	4	4
C2020	CRD.35.905.0	25	2
	CRD.35.905.1	25	2
	CRD.35.906.0	9	1
C2021	CRD.35.904.0	25	6
	CRD.35.905.0	7	2
	CRD.35.905.1	7	2
	CRD.35.907.0	8	2
C2022	CRD.35.904.0	30	1
C2023	CRD.35.902.0	11	2
	CRD.35.905.1	26	1
	CRD.35.907.0	6	2
C2023.01.00	CRD.35.905.0	17	2
	CRD.35.905.1	17	1
C2025.00.01	CRD.35.903.0	8	8
C2029.00.01	CRD.35.904.0	11	2
C2033	CRD.35.902.0	5	2
	CRD.35.907.0	10	2
C2035	CRD.35.901.0	8	6
C2041	CRD.35.905.0	22	1
	CRD.35.905.1	22	1
C2050.03.00	CRD.35.901.0	14	6
	CRD.35.905.0	2	4
	CRD.35.905.1	2	4
C2051	CRD.35.904.0	18	1

Code	Parts Table	Pos.	Q.ty
C2062	CRD.35.905.1	18	1
	CRD.35.907.0	5	2
C2063	CRD.35.901.0	9	7
C2064	CRD.35.901.0	10	4
C2071.00.02	CRD.35.903.0	10	2
C2088	CRD.35.901.0	12	6
C2092	CRD.35.901.0	13	6
C2100.00.01	CRD.35.901.0	1	1
C2100.02.01	CRD.35.901.0	4	1
C2100.02.02	CRD.35.901.0	5	1
C2100.02.03	CRD.35.901.0	6	1
C2100.02.04	CRD.35.901.0	3	1
C2100.03.00	CRD.35.904.0	27	1
C2100.04.00	CRD.35.905.0	3	2
	CRD.35.905.1	3	2
C2100.05.00	CRD.35.904.0	5	1
C2110.01.01	CRD.35.905.0	1	1
	CRD.35.905.1	1	1
C2110.01.01.t	CRD.35.905.0	1	1
C2110.01.02	CRD.35.905.0	19	1
	CRD.35.905.1	19	1
C2110.01.03	CRD.35.905.0	20	1
	CRD.35.905.1	20	1
C2110.02.00	CRD.35.904.0	13	1
C2110.02.01	CRD.35.904.0	21	1
C2110.02.02	CRD.35.904.0	14	1
C2110.02.03	CRD.35.904.0	12	1
C2110.03.00	CRD.35.904.0	6	1
C2110.03.02	CRD.35.904.0	16	1
C2110.03.04	CRD.35.904.0	29	1
C2110.03.05	CRD.35.904.0	32	1

Code	Parts Table	Pos.	Q.ty
C2110.03.06	CRD.35.904.0	34	1
C2110.05.00	CRD.35.906.0	4	1
C2110.06.00	CRD.35.906.0	3	1
C2110.07.00	CRD.35.906.0	2	2
C2110.08.00	CRD.35.906.0	1	1
C2130.01.01	CRD.35.907.0	3	1
C2130.01.02	CRD.35.907.0	2	2
C2130.01.03	CRD.35.907.0	1	1
C2130.02.00	CRD.35.907.0	13	1
C2130.02.01	CRD.35.907.0	14	1
C2130.03.00	CRD.35.907.0	9	1
C2140.01.10	CRD.35.903.0	6	1
C2140.01.11	CRD.35.903.0	6	1
C2140.06.00	CRD.35.903.0	3	4
C2140.07.00	CRD.35.903.0	4	4
C2140.07.01	CRD.35.903.0	5	2
C2140.11.00	CRD.35.903.0	11	2
C2140.21.00	CRD.35.902.0	7	2
C2140.22.01	CRD.35.902.0	1	1
C2160.01.01	CRD.35.901.0	2	1
C2160.04.00	CRD.35.905.0	9	1
	CRD.35.905.1	9	1
C2160.04.01	CRD.35.905.0	12	1
	CRD.35.905.1	12	1
C2160.04.02	CRD.35.905.0	8	1
	CRD.35.905.1	8	1
C2160.05.00	CRD.35.901.0	7	1
C3040.13.06	CRD.35.905.0	15	1
	CRD.35.905.1	15	1